

# MEDIUM TO LARGE WALL LIGHTS

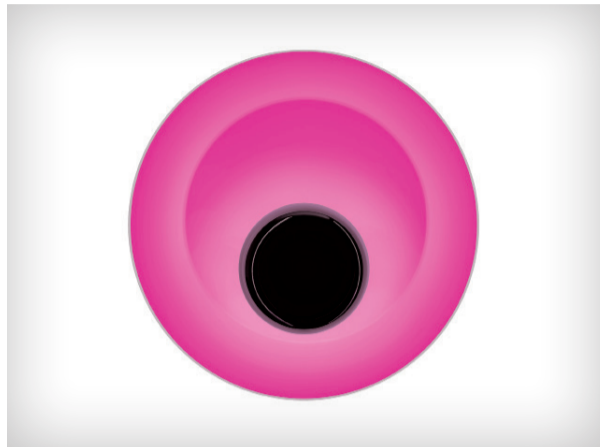

Product Name: Dawn  
 Designer: Marco Merendi  
 Manufacturer: Kundalini  
 IP: 20  
 Light Source: LED 1 x 17W- 2700K -CRI>80  
 Material: Luminaire body  
 Finishes: White and Black Chrome, White or Polished Copper

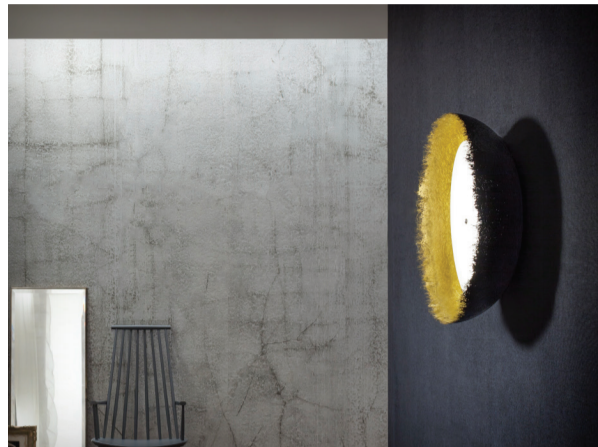

Product Name: Egida  
 Designer: Sandro Santantonio  
 Manufacturer: Lucente  
 IP: 20  
 Light Source: LED 29,2W 3.000K  
 Material: Fiberglass  
 Finishes: Matt White - Silver Leaf or Matt Black - Gold Leaf

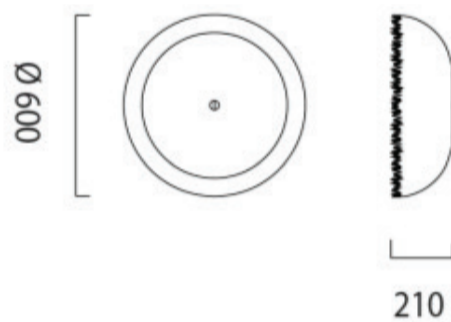

Product Name: Lunaire  
 Designer: Ferreol Babin  
 Manufacturer: Fontana Arte  
 IP: 20  
 Light Source: 1 x 55w 2Gx13 (FL)  
 Material: Aluminium  
 Finishes: White or Black

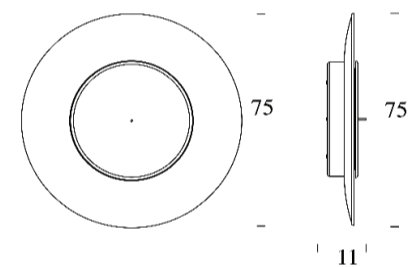

Product Name: Eight  
 Designer: Sandro Santantonio Design  
 Manufacturer: Lucente  
 IP: 20  
 Light Source: E27 2x24W TC-TSE  
 Material: Metal  
 Finishes: White, Chrome or Copper

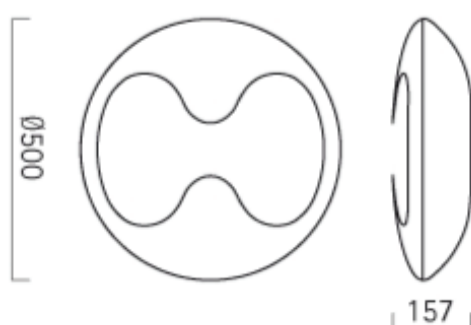

Product Name: Pixel  
 Designer: Bakery Group  
 Manufacturer: Kundalini  
 IP: 20  
 Light Source: Fluorescent 3 x E14 12W  
 Material: Polyethylene  
 Finishes: White

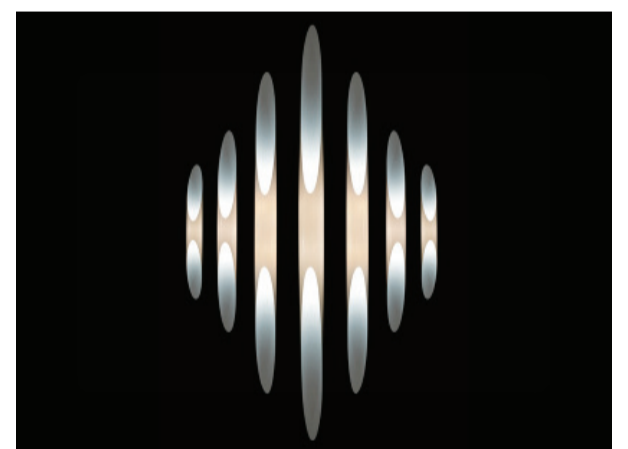
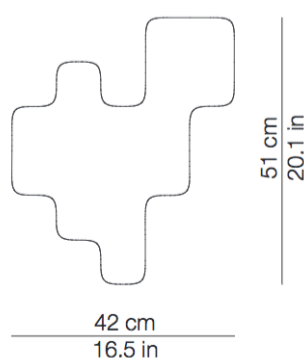

Product Name: Shakti  
 Designer: Marzio Rusconi Clerici  
 Manufacturer: Kundalini  
 IP: 20  
 Light Source: Fluorescent 1 x 7W E27 / LED 1 x 16W E27  
 Material : Coextruded and laser cut Plexiglas  
 Finishes: White

